

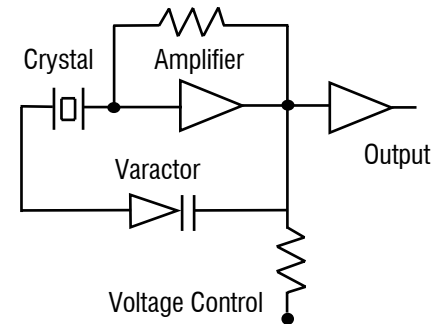

What is a VCXO ?

Unlike regular clock oscillator which has fixed output frequency, the output frequency of a **VCXO** (also known as “**frequency modulator**”) can be tuned $\pm 50 \sim \pm 200$ ppm up or down from the nominal frequency by varying the control voltage on the voltage control pin. Varactor, a voltage variable capacitance tuning diode, is used to achieve this purpose.



Applications of VCXO include (PLL) phase lock loop, SONET/ATM, set-top boxes, MPEG , audio-video modulations, video game consoles and HDTV sets.

Product Summary:

Package Code	Frequency Range	Assembly Technique	Package Size (mm) [inches]
Thru-Hole Types			
G14	500 kHz ~ 170 MHz	4 pin DIL full size	12.8 x 20.2 x 5.88H [0.504 x 0.795 x 0.231]
G8	500 kHz ~ 170 MHz	4 pin DIL half size	12.8 x 12.8 x 5.88H [0.504 x 0.504 x 0.231]
Surface Mount Types – Gull Wing			
G24	500 kHz ~ 170 MHz	Gull wing version of G14	12.8 x 20.2 x 7.6H [0.504 x 0.795 x 0.300]
G18	500 kHz ~ 170 MHz	Gull wing version of G8	12.8 x 12.8 x 7.6H [0.504 x 0.504 x 0.300]
Surface Mount Types – Leadless			
G61	500 kHz ~ 170 MHz	6 pad FR4 Leadless	9.6 x 11.4 x 1.85H [0.378 x 0.449 x 0.073]
G62	500 kHz ~ 170 MHz	6 pad FR4 Leadless	9.6 x 11.4 x 2.5H [0.378 x 0.449 x 0.098]
G42	500 kHz ~ 170 MHz	4 pad FR4 Leadless	9.6 x 11.4 x 2.5H [0.378 x 0.449 x 0.098]
G64	500 kHz ~ 170 MHz	6 pad FR4 Leadless	9.6 x 11.4 x 4.7H [0.378 x 0.449 x 0.185]
G44	500 kHz ~ 170 MHz	4 pad FR4 Leadless	9.6 x 11.4 x 4.7H [0.378 x 0.449 x 0.185]
G57	2 MHz ~ 60 MHz	4 pad Ceramic Leadless	5.0 x 7.0 x 1.7H [0.197 x 0.275 x 0.067]
G576	2 MHz ~ 60 MHz	6 pad Ceramic Leadless	5.0 x 7.0 x 1.7H [0.197 x 0.275 x 0.067]
G575	500 KHz ~ 170 MHz	6 pad Leadless	5.0 x 7.5 x 2.65H [0.197 x 0.295 x 0.104]

MERCURY www.mercury-crystal.com

Taiwan: TEL (886)-2-2695-7099, FAX (886)-2-2695-7473, e-mail: sales-tw@mercury-crystal.com

U.S.A.: TEL (1)-909-466-0427, FAX (1)-909-466-0762, e-mail: sales-us@mercury-crystal.com

**"G" series General Specifications** $T_A = +25^\circ\text{C}$, $V_{DD} =$ At specified voltage, $C_L = 15\text{ pF}$

		3.3 V System	5.0 V System
Input Voltage (V_{DD})		$V_{DD} = +3.3\text{ V D.C. } \pm 5\%$ Control Voltage Center (V_c) = +1.65 V Voltage code is "3"	$V_{DD} = +5.0\text{ V D.C. } \pm 5\%$ Control Voltage Center (V_c) = +2.5 V Voltage code is "5"
Initial Frequency Accuracy (at +25°C)		To tune to the nominal frequency with $V_c = 1.65\text{ V} \pm 0.2\text{ V}$	To tune to the nominal frequency with $V_c = 2.5\text{ V} \pm 0.2\text{ V}$
Frequency Range	Commercial temperature (0°C to +70°C)	500 kHz ~ 100 MHz	500 kHz ~ 156 MHz
	Industrial temperature (-40°C to +85°C)	500 kHz ~ 90 MHz	500 kHz ~ 140 MHz
Output Voltage HIGH "1"	TTL	2.4 V min.	2.4 V min.
	CMOS	2.97 min.	$V_{CC} - 0.5$ min.
Output Voltage LOW "0"	TTL	0.4 V max.	0.4 V max.
	CMOS	0.33 max.	0.5 V max.
Frequency Pulling Range		From ± 30 ppm to ± 150 ppm Control Voltage Range: 0.3 V to 3.0 V	From ± 80 ppm to ± 200 ppm Control Voltage Range: 0.5 V to 4.5 V
Frequency Stability ⁽¹⁾ Commercial temp. range (code "C")		<p>"A": ± 25 ppm over 0°C to +70°C "B": ± 50 ppm over 0°C to +70°C "C": ± 100 ppm over 0°C to +70°C For non-standard please give desired frequency stability after the "C". For example "C20" is ± 20 ppm over 0 to +70°C</p>	
Frequency Stability ⁽¹⁾ Industrial temp. range (code "I")		<p>"D": ± 25 ppm over -40°C to +85° (not available on all packages) "E": ± 50 ppm over -40°C to +85°C "F": ± 100 ppm over -40°C to +85°C For non-standard please give desired frequency stability after the "I". For example "I20" is ± 20 ppm over -40 to +85°C</p>	
Output Load	TTL	5 ~ 10 TTL gates	
	CMOS	15 ~ 50 pF	
Rise Time (T_r) and Fall Time (T_f)	TTL	5 n Sec. max; 2 n Sec. typical. Measured between 0.4V to 2.4V ($R_L = 390\ \Omega$; $C_L = 15\text{ pF}$)	
	CMOS	5 n Sec. max; 2 n Sec. typical. Measured between 10% to 90% V_{DD} ($C_L = 15\text{ pF}$)	
Duty Cycle	TTL	40% min. 60% max. (measured at +1.4 V)	
	CMOS	40% min. 60% max. (measured at 50% V_{DD})	
Start-up Time (T_s)		10 m Sec. max. 5 m Sec. typical	
Linearity		10% max.; 6% typical	
Slope Polarity (Transfer Function)		Monotonic and Positive: Increasing control voltage always increases output frequency. Negative slope is also available.	
Current Consumption		15 ~ 45 mA (frequency dependent)	
Modulation Bandwidth ($\pm 3\text{ dB}$)		10 kHz min.	
Input Impedance		10 k Ω at 10 kHz min.	
Storage Temperature		-40°C to +85°C	
Aging		± 5 ppm per year max.	
Jitter, one sigma, 155.520 MHz, +5 V		25 ps typical, 28 ps max.	

⁽¹⁾Inclusive of 25°C tolerance, operating temperature range, $\pm 10\%$ input voltage variation, load change, aging, shock and vibration.



Ordering Information:

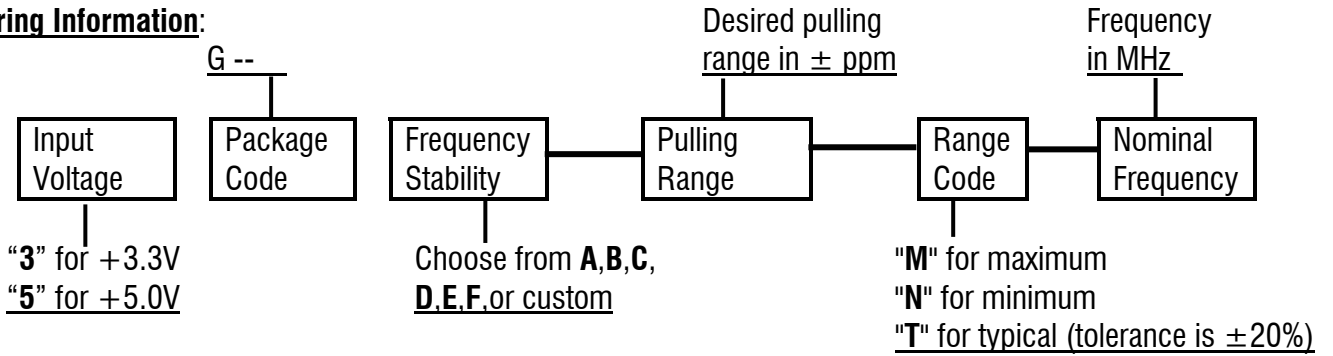

Part Number Examples:

3G44B-120T-54.000

represents 54.0 MHz VCXO in G44 package, frequency stability is ± 50 ppm from 0°C to +70°C, pullability is ± 120 ppm typical, +3.3 V.

Output Waveform:

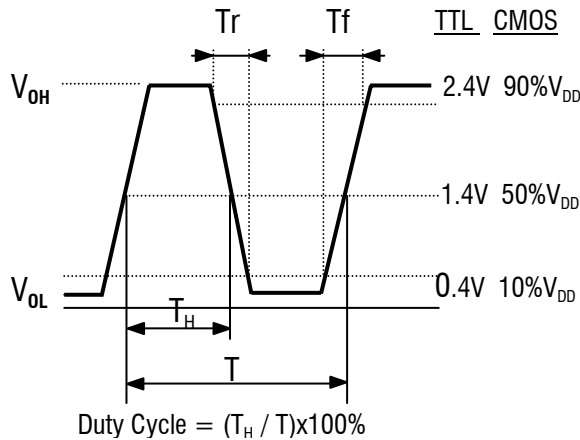

Transfer Function: Typical response of 5G14C-150N-27.000 (at +25°C, positive transfer)

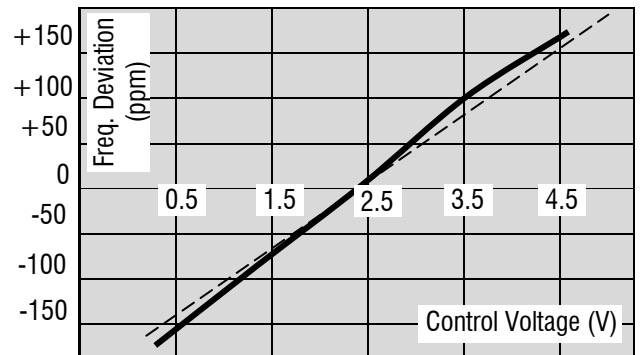

" - - - - - " : Theoretical 0% non-linearity

SSB Phase Noise: 155.520 MHz at +3.3V

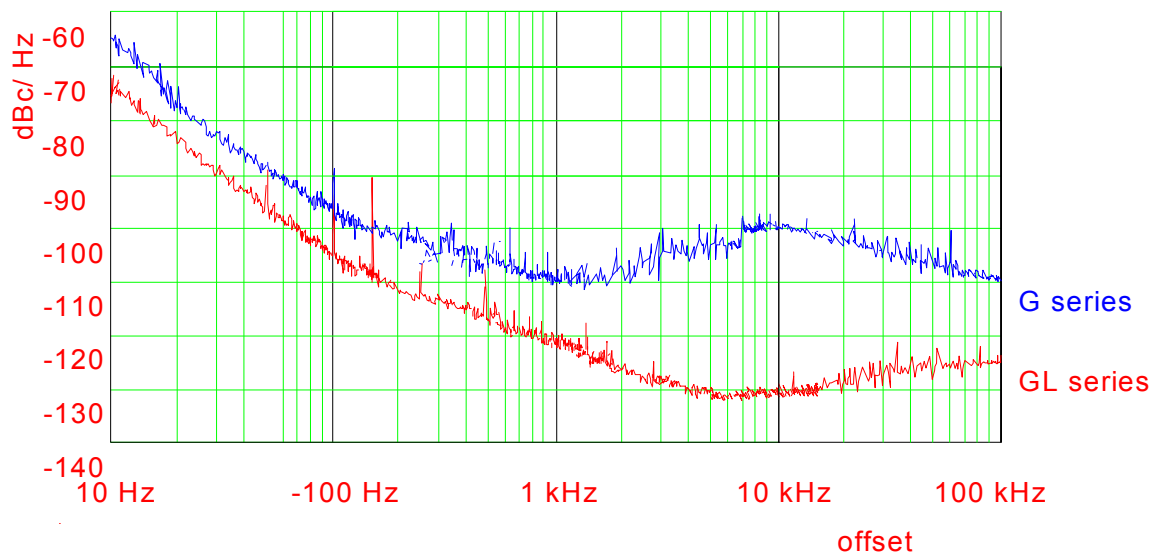

Package: G14

Unit: mm [inches]

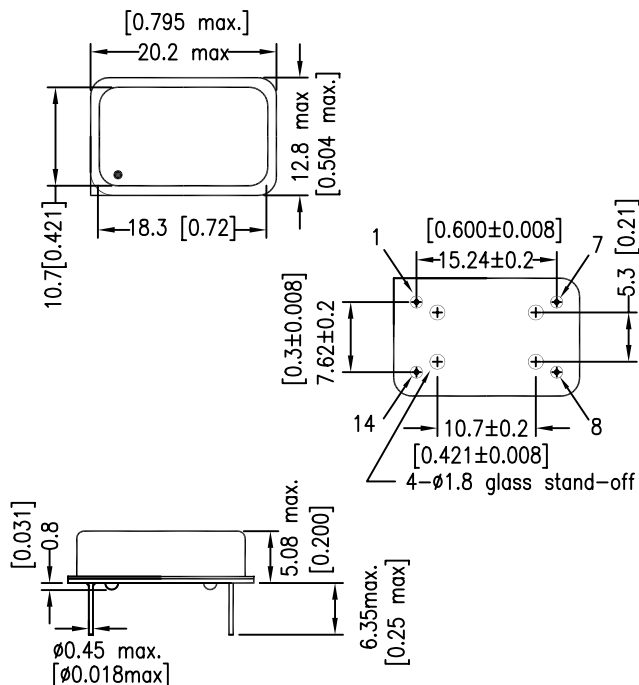

Pin Connections

Square corner denotes pin 1

- Pin 1: Voltage Control
- Pin 7: Ground
- Pin 8: Output
- Pin 14: Supply Voltage

Package: G8

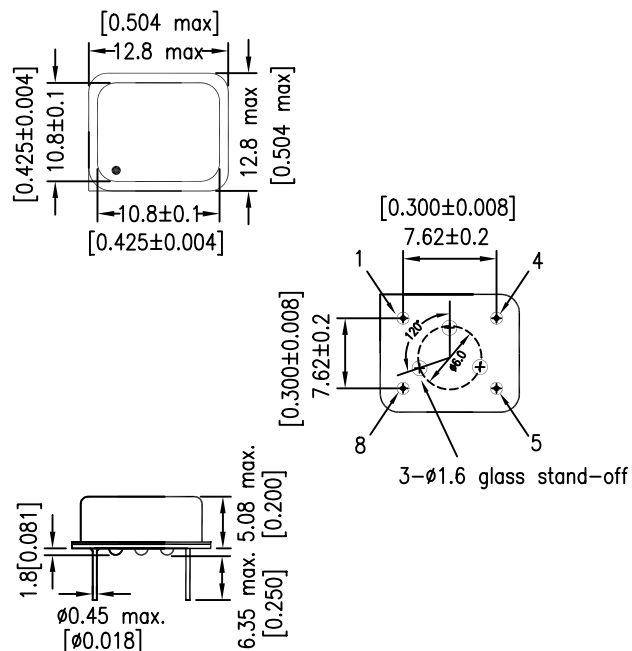

Pin Connections

Square corner denotes pin 1

- Pin 1: Voltage Control
- Pin 4: Ground
- Pin 5: Output
- Pin 8: Supply Voltage

V C X 0
TTL,HCMOS

Package: G24

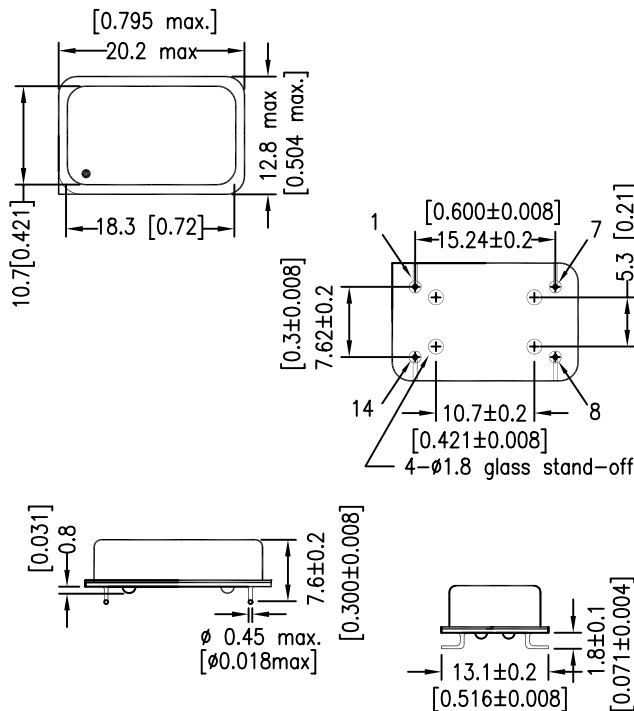

Pin Connections

Square corner denotes pin 1

- Pin 1: Voltage Control
- Pin 7: Ground
- Pin 8: Output
- Pin 14: Supply Voltage

Package: G18

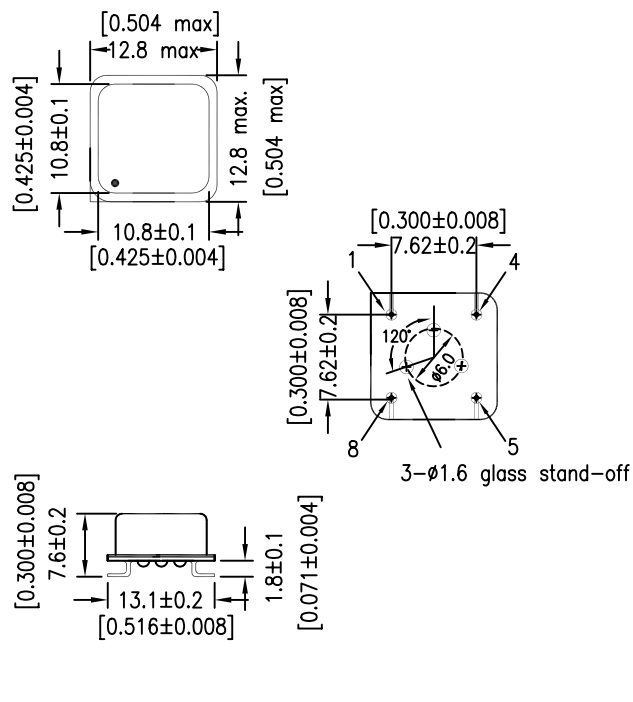

Pin Connections

Square corner denotes pin 1

- Pin 1: Voltage Control
- Pin 4: Ground
- Pin 5: Output
- Pin 8: Supply Voltage

Package: G44

"44" represents 4 pads and 4.7 mm overall height

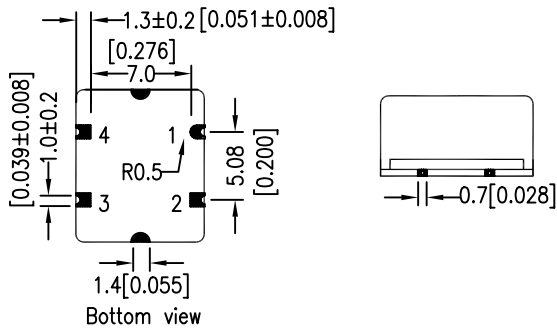
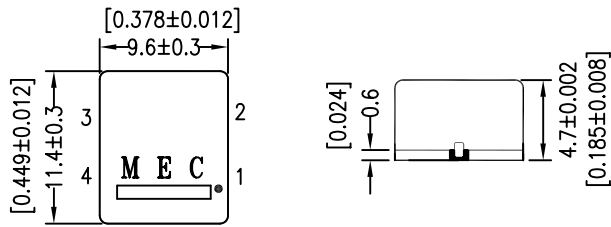

Pad Connections:

- Pad 1: Voltage Control (rounded pad)
- Pad 2: Ground
- Pad 3: Output
- Pad 4: Supply Voltage

Package: G64

"64" represents 6 pads and 4.7 mm overall height

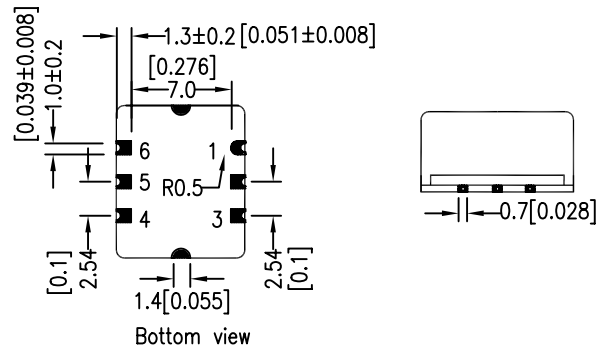
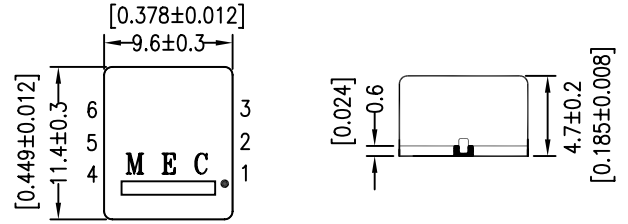

Pad Connections:

- Pad 1: Voltage Control (rounded pad)
- Pad 2: Tri-State
- Pad 3: Ground
- Pad 4: Output
- Pad 5: No Connection
- Pad 6: Supply Voltage

V C X 0
TTL,HCMOS

Package: G42

"42" represents 4 pads and 2.5 mm overall height

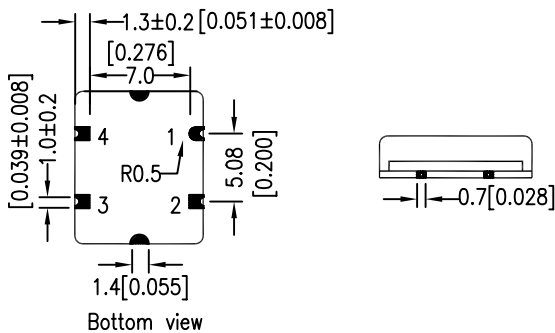
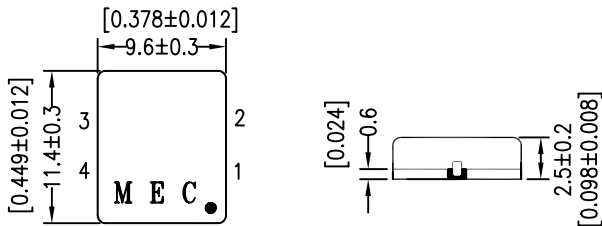

Pad Connections:

- Pad 1: Voltage Control (rounded pad)
- Pad 2: Ground
- Pad 3: Output
- Pad 4: Supply Voltage

Package: G62

"62" represents 6 pads and 2.5 mm overall height

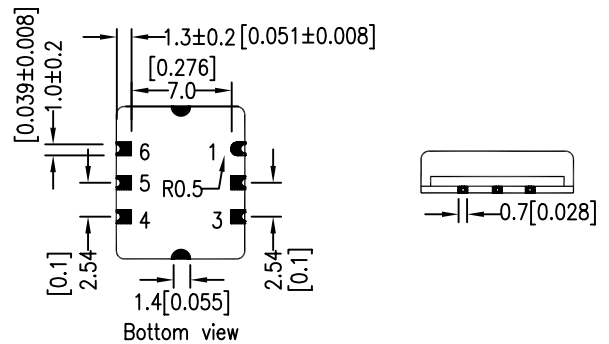
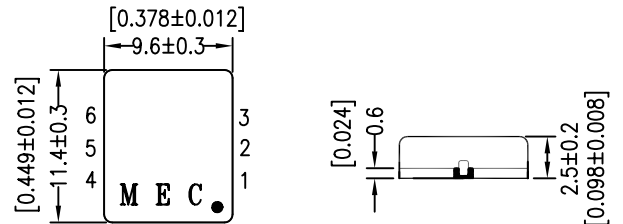

Pad Connections:

- Pad 1: Voltage Control (rounded pad)
- Pad 2: Tri-State
- Pad 3: Ground
- Pad 4: Output
- Pad 5: No Connection
- Pad 6: Supply Voltage

Package: G61

"61" represents 6 pads and 1.85 mm overall height

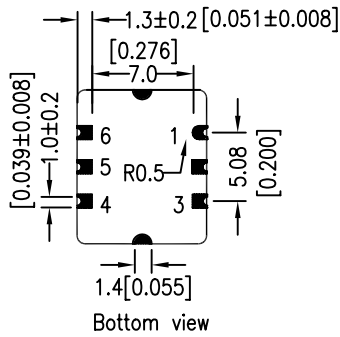
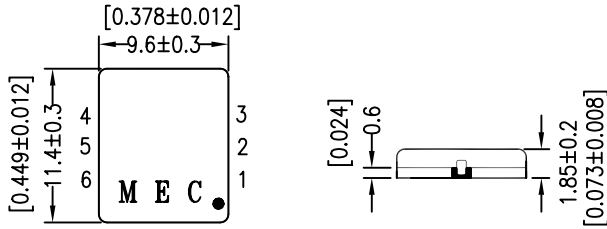

Bottom view
Rounded pad is pad No. 1

Pad Connections:

- Pad 1: Voltage Control
- Pad 2: Tri-State
- Pad 3: Ground
- Pad 4: Output
- Pad 5: No connection
- Pad 6: Supply Voltage

Package: G575

Unit: mm [inches]

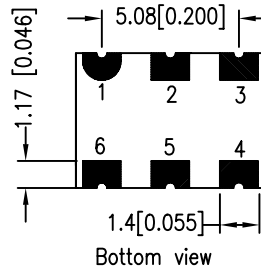
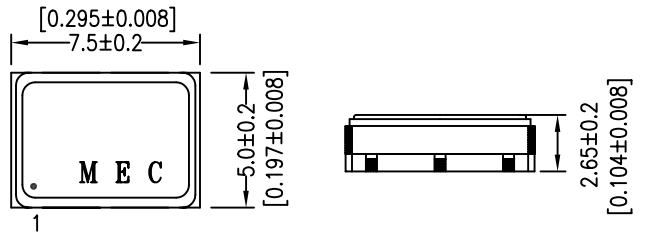

Bottom view

Rounded pad is pad No. 1

Pad Connections:

- Pad 1: Voltage Control
- Pad 2: Tri-State
- Pad 3: Ground
- Pad 4: Output
- Pad 5: No connection
- Pad 6: Supply Voltage

V C X O
TTL, HCMOS

Package: G57 4 Pads

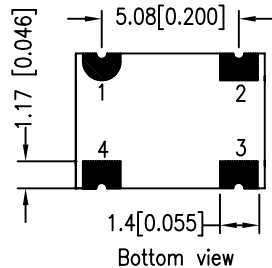
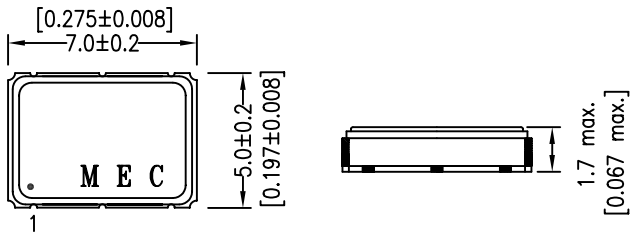

Bottom view

Rounded pad is pad No. 1

Pad Connections:

- Pad 1: Voltage Control
- Pad 2: Ground
- Pad 3: Output
- Pad 4: Supply Voltage

Package: G576 6 pads

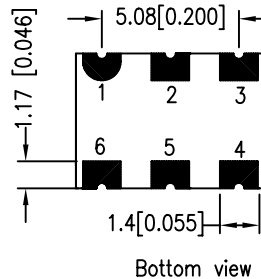
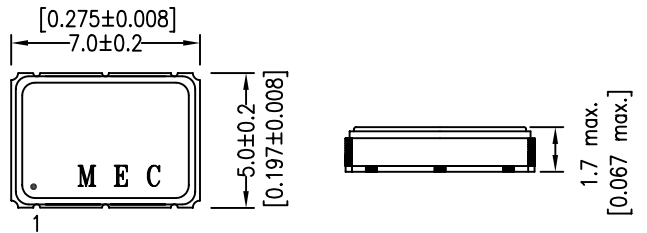

Bottom view

Rounded pad is pad No. 1

Pad Connections:

- Pad 1: Voltage Control
- Pad 2: Tri-State
- Pad 3: Ground
- Pad 4: Output
- Pad 5: No connection
- Pad 6: Supply Voltage